

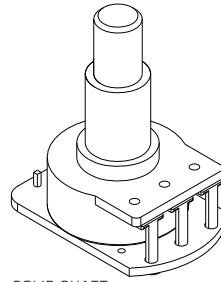

0230-0162B

PO BOX 4394
SANTA ROSA, CA
95402 USA

P (707) 525-9941
F (707) 575-7046
EMGPICKUPS.COM



SOLID SHAFT

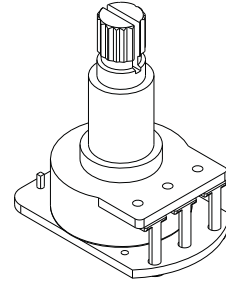

SPLIT SHAFT

INSTALLATION INFORMATION

EMG MODEL: **B124 TONE CONTROL** (ACTIVE PICKUP INPUT 25K OHM, BLACK PC BOARD) (PASSIVE PICKUP INPUT 500K OHM, GREEN PC BOARD)

GENERAL OPERATION

The B124 Passive Tone control is included with original EMG Pickups and Pickup Systems. There are two versions, 25K Ohm for Active EMG's and 500K Ohm for EMG-HZ Passive Pickups. The 25K Ohm control has a black PC Board, the 500K has a green PC Board, both are Audio Taper. The wiring configuration is the same for both 25K and 500K Controls. The tone capacitor is small and is mounted on the pot side of the PC Board. There are 4 header pins, (2 pairs of signal and ground) the two pairs are identical so either can be used for tone control with the second pair for in/out. Examples are shown in the included diagrams. The B124 features plug-in compatibility with all EMG Pickup Systems by using .100 (2.54mm) standard pin spacing. You can solder to the control by using the 2 solder pads on the PC Board if connectors are not available, 1 of the solder pads is for input and the other pad is for ground, see below.

Schematic Diagram: B124 Tone Control

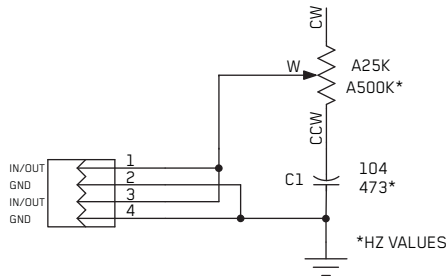
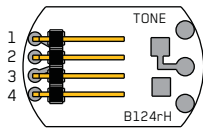

*HZ VALUES

Dimensions: B124 Tone Control

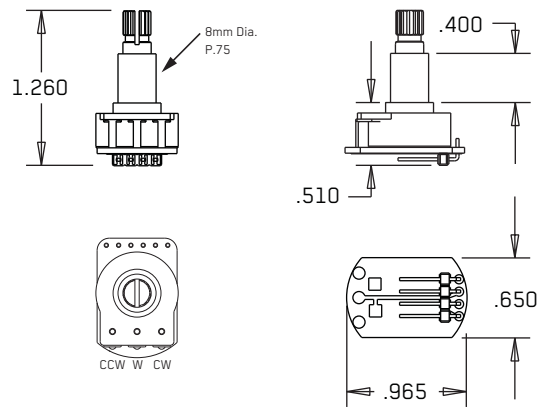

SCHEMATIC NOTES:

The Schematic diagram above shows how the B124 Tone control is configured. Pins 1 and 2 are the input to the CW (Clockwise) terminal of the control. Pins 3 and 4 are a duplicate of the CW (Clockwise) terminal of the control. Pins 2 and 4 go directly to ground.

SOLDERING:

If you don't have connector cables, or prefer to solder to the control, solder pads are provided. The diagram to the right shows the pads for soldering.

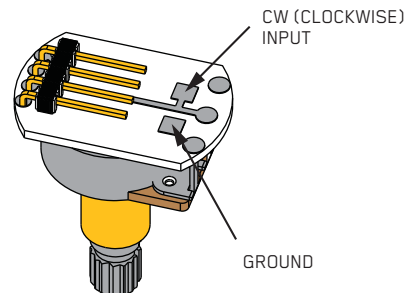

The EMG coax cables for wiring the guitar are a 2-pin pair, The signal or "Hot" wire is White, the Ground (Shield) wire is Black.

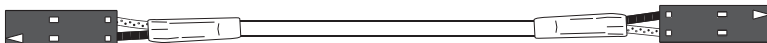

DIAGRAM NOTES:

Pairs 1-2 and 3-4 are interchangeable, both are the CW pair.

Passive tone controls like the B124 are wired parallel to the signal of the pickup, or at the output of the instrument. There is only an "input", not an output of a passive tone control. The B124 has two additional header pins (3-4) that could be called "signal-thru" or "pass-thru" so that if the instrument is wired with a master tone control, the signal to the output jack can be gotten from the tone control. This is most useful if the instrument is wired Volume/Volume/Master Tone and does not have a selection switch. The diagrams below will further explain.

Diagram #1

Tone control input on either pair 1-2 or 3-4

"Signal-thru" to output jack on either pair 1-2 or 3-4

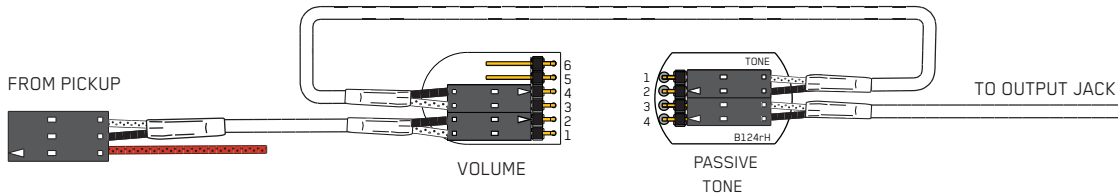

Independent volume with 2 pickups and no selection switch:

Diagram #2 illustrates another example of the benefit of the second set of pins on the tone control, it shows a similar wiring arrangement as above but in an instrument with two pickups and no selection switch. This is similar to a Fender Jazz Bass*.

Diagram #2

NECK PICKUP

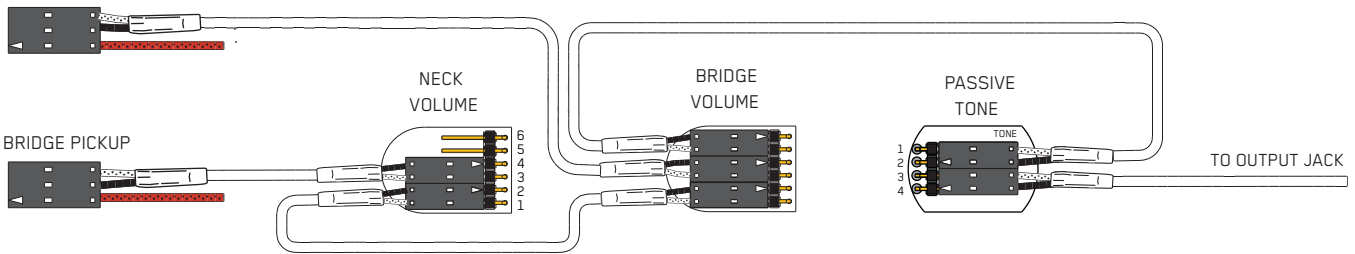

Independent Volume with 2 pickups and a selection switch:

Diagram #3 shows a very typical tone control wiring for a Les Paul style guitar, two pickups with a selection switch. As you can see, the tone controls have a coax cable going to pins 1-2 (or 3-4). This illustrates that there is only an "input" needed to the tone control, and in this instance the signal is not being "passed-thru".

Diagram #3

